



ROBERT

2 COLUMBUS CIRCLE, NEW YORK CITY | 212 206 8815

# Congratulations!

Located at the top of the Museum of Arts & Design, ROBERT floats like a crowned jewel above Columbus Circle. As the elevator doors open to panoramic views of Central Park and the Manhattan skyline, you can experience dining above the treetops in the whimsical elegance of this curated, contemporary space. Whatever the occasion, every season is perfect for special events at ROBERT. Details and particulars are meticulously cared for, so you can indulge in celebration while enjoying our breathtaking view.



ROBERT is proud to feature the culinary talents of Chef Armando Cortes.

ROBERT offers a selection of both seated and buffet menus to compliment your special day.

*Thank you* for considering ROBERT for your upcoming Wedding!

Our event experts will work with you to customize the menu for your event. A tantalizing cocktail reception comprised of deluxe open bar, a specialty cocktail, butler-passed hors d'oeuvres and a grazing station will precede a gourmet three course meal including appetizer, choice of two entrées, dessert, wine service with dinner and unlimited sparkling wine.

Our complete menus are available to [view and download](#).

Brunch and lunch menus available upon request.

The next pages are a guideline to display what is included.



SAMPLE

# Cocktail Reception

## WARM & COLD PASSED HORS D'OEUVRES

**Mexican Grilled Corn Avocado Toast** V

**Crispy Veggie Spring Rolls** GF,  
Mango Chili Sauce

**Spicy Tuna Tartare** GF

in Taro Chips

**Baby Lamb Chops** GF

Balsamic Glaze

**Devils on Horseback** GF

Blue Cheese Stuffed Dates Wrapped in Bacon

**Petite Filet Mignon Wellington**

Fig Compote

**Peruvian Mahi Mahi Ceviche** GF

**Fish & Chips Mini Cone** GF

Plus, A Beautifully Presented Grazing Station

## ANTIPASTO

**Grilled Asparagus & Pecorino Romano** GF, V

**Melon & Prosciutto di Parma** GF

**Grilled Seasonal Vegetables** GF, V

**Salami, Sopressata, Coppa**

**Mozzarella, Heirloom Tomato, Fresh Basil** GF, V

**Bowls of Assorted Olives**

**Parmesan, Fontina & Gorgonzola  
with Dried & Fresh Fruits** V

**Assortment of Grissini, Focaccia & Ru:  
& Herbed Olive Oil**

SAMPLE  
*Dinner Menu*

APPETIZER

**Roasted Beets & Baby Arugula V**

Goat Cheese Fondue, Challah Toast, Pomegranate Reduction

MAIN COURSE

**Clearwater Farms Filet Mignon** Potato Gratin, Sautéed Baby Kale, Sauce Robert

OR

**Branzino** Puttanesca Vegetables, Olive Tapenade, Oreganata

SILENT VEGETARIAN

Option Also Available

**Herb-Crusted Cauliflower Steak VG**

Small Potatoes, Beans and Tomatoes

---

A Wedding Cake, if desired, may be arranged with and brought in by an outside baker.

ROBERT does not charge fees to slice and plate your Wedding Cake.

To help satisfy your sweet tooth, a display of petite sweets is offered, all baked in-house!

PETITE SWEETS

**Cheesecake Lollipops**

**Red Velvet Cupcakes**  
with Cream Cheese Icing

**Macaron Trio**

**Fresh Fruit Skewers**

**Chocolate Pot de Crème**

**Lemon Meringue Bars**

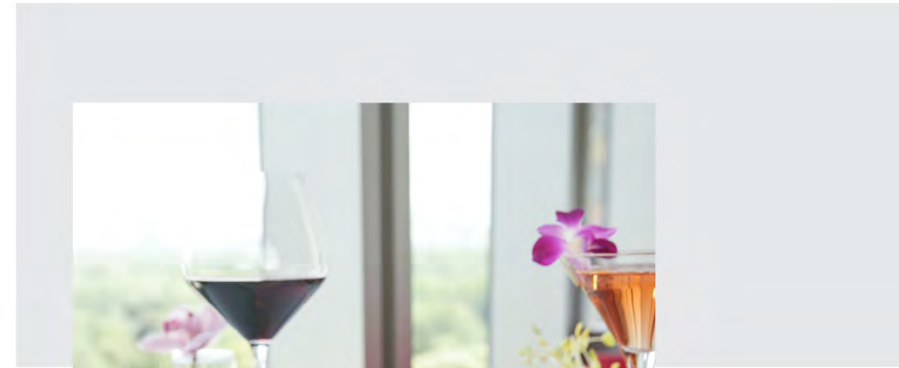



SAMPLE

## Deluxe Open Bar

### LIQUOR

Grey Goose Vodka | Ketel One Vodka | Tito's Vodka | Bombay Sapphire Gin  
Bacardi Silver Rum | Patron Silver Tequila | Herradura Silver Tequila | Woodford Reserve Bourbon  
Michter's Rye | Slane Irish Whisky | Johnny Walker Black Scotch | Hennessy VSOP Cognac | Jameson Irish Whiskey

### SPARKLING WINE

LaMarca Prosecco, Italy

### STILL WINE

Selection of one white and one red wine

WHITE Matua, Sauvignon Blanc, Marlborough, New Zealand | Domaine des Vercheres Macon-Villages 2020

RED J Vineyards, Pinot Noir, California | St. Huberts, The Stag, Cabernet Sauvignon, California

ROSÈ The Palm by Whispering Angel, Côtes de Provence, France

### BOTTLED BEER

Heineken, Holland | Ark Everyday Ale (session IPA), Bronx | American Pale Ale, Bronx |  
Abita Light, Louisiana | Fire Island Beer Co. Lighthouse Ale (Amber Ale)

### SOFT DRINKS

Sparkling Mineral Water, Sodas, Juices, Tonic & Club Soda, Garnishes

Our complete menus are available to [view and download.](#)



Eclectic colors, chandeliers, Lucite chairs and velvet lounge sofas create the quintessential contemporary setting. The restaurant was named for award-winning designer, Robert Isabell, who believed originality was the most important entity for a successful event. ROBERT upholds this ethos. Sophisticated, celebratory and sexy, ROBERT is a modern classic.



Our expert event specialists will assist in creating the perfect event including the presentation of multiple options for catering as well as an extensive wine and beverage list, and the ability to transform the restaurant into the event space of your dreams. In addition, with the versatility of a private room on the 7th floor and a full-sized screening room in the museum, the possibilities for weddings, corporate events and celebrations are endless. With our professionalism and attention to detail, you can be assured that every aspect of your event is made perfect.

# Facts and Questions



## **Will my wedding be in a private room at the restaurant?**

We accommodate special events in our restaurant dining room by closing our business to the public. There are no dedicated private dining rooms at Robert. There is a white box event space located within the Museum, downstairs from Robert, which can hold stand-alone events or may be utilized in conjunction with ROBERT events.

## **Is there a separate buyout fee to close the restaurant?**

Our pricing is structured as a package price which includes the value of the business lost by closing to the public, based on day/date/time of the event, as well as the cost of food and beverage arranged for the event, as determined by the number of anticipated guests, and ultimately menu selections.

## **Is there a wedding ceremony fee?**

There are several options for your ceremony to be held onsite before your wedding reception at Robert. We can arrange an informal ceremony alongside the reception in Robert for up to 75 guests. You may rent the 7th floor private museum space for an additional fee, which includes chair rental and set up. Or, rental of the MAD theater, which seats up to 143 people, may be discussed directly with the museum special events department.

For Jewish ceremonies, Robert can provide a glass for breaking (light bulb) and Challah Bread for the blessing. Arrangements for these items should be made in advance with your Catering Manager.

The Chuppah and/or Arch, as well as an aisle runner, if applicable, is the responsibility of the Client.

## **Are there any other charges aside from the package price?**

The package price is subject to a 24% administrative charge, captain fee(s), bar set up fee(s), and coat check fees. Any administrative charge, and any captain fee, bar set-up fee, coat check fee, and supplemental staff fees (if applicable), are not gratuities and will not be given to the wait staff or any other employee. These fees will be retained entirely by the restaurant as part of the contract price that is used to cover costs and overhead relating to the catered event. The banquet wait staff is paid a special banquet hourly rate well in excess of the statutory minimum wage rates and are notified that the administrative charge and these fees are not intended to be a gratuity and will not be distributed to them.

*We invite you to contact us for a customized proposal, detailing pricing and fees, based on your anticipated date and group size.*



## **Can I use my own vendors?**

Absolutely. In the interest of personalizing your event, we welcome outside vendors, including music, florist, lighting, photography and videography. Alternatively, we are happy to share vendors with who we've worked successfully in the past. All vendors must carry the required insurance that is stipulated in our contracts.

## **Do you provide vendor meals?**

Vendor meals (i.e. for musicians, DJ, photographer, etc.) working with your event are to be requested 1 week prior to the event date and are an additional charge. The meal includes the chef's choice of hot entrée and non-alcoholic beverages.

## **Is transportation readily available for my guests after a wedding?**

Taxis are available in Columbus Circle and cars can drop off and pick up guests in front of the building on West 59th Street. In addition, MAD is located on top of the 59th Street/Columbus Circle subway station, allowing for easy access to the B, D, A, C, 1, 2 and 3 subway lines.

## **Is there parking available for my wedding guests?**

Parking garages are conveniently located nearby, including Champion Parking (located at 221 West 58th Street between Broadway & 7th Avenue) or Central Parking (at the Time Warner Center, 10 Columbus Circle, between 8th & 9th Avenues).

## **When can I drop off items to be used for my event (i.e. seating cards, favors, etc.)?**

# More Facts and Questions

One day prior to the wedding date, to be coordinated with the Event Director.

## Does Robert offer Glatt Kosher Meals or Catering?

Yes, Robert works with some of the premier Kosher Caterers in New York to offer the finest in Kosher Food.

## What is the ratio of servers to guests?

Elegant and contemporary service is provided with 1 waiter per 10 guests, with bar service with 1 bartender per 75 guests. Additional staff required to accommodate Client requests is at the Client's responsibility.

## Is overtime available for our After Party?

Extending your event beyond the contracted time will increase the per person price by \$35 per person per hour (or \$25 per person per half hour) based on the guaranteed guest count. The additional charge includes bar service, and is subject to 24% administrative charge & sales tax.

## Is the bar open all night?

There is always a bartender available to serve guests from the bar. Also, the waiters offer wine service and will accommodate drink requests to the dinner tables as well.

## Is the venue wheelchair accessible?

Upon arrival and request for the Rooftop or lower level restrooms, guests will be directed to the stairwell for efficiency, though Robert has a fully operational service elevator available upon request. Both the mens' and women's restrooms have wheelchair accessible facilities and are gender neutral.

## What type of food does Robert serve?

Robert serves contemporary American/Continental cuisine, expertly prepared by Executive Chef Armando Cortes.

## Is there a menu tasting for my wedding?

For plated menus, Robert is pleased to offer a single, complimentary menu tasting/consultation for up to 4 guests, to be scheduled 60-90 days prior to the event date. Our Chef schedules tastings Mondays-Wednesdays at 5:30pm. A minimum of three weeks' notice is required.

## Does Robert offer special pricing for children?

Children aged 4-11 years old are eligible for half-price, while children under 4 years old are complimentary. Special children's menus can be arranged with your Catering Manager, if so desired.

## Does Robert provide a Bridal Suite on the day of my wedding?

While there is no bridal suite nor changing room of any kind at Robert or in the Museum of Arts & Design, we are happy to assist with referrals to nearby hotels upon request.

Have questions or want to check available dates?  
Contact our special events team at 212-206-8815.

PHOTOGRAPHY CREDITS: Lucas Noonan, Kaden Shallat, Jackie Marie Photography, Aleksey Fedoro, Mike Petrie Jr., Andre Maier, Robert Leslie.

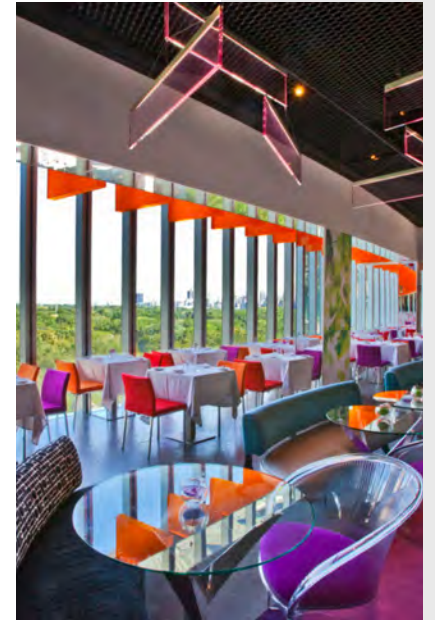
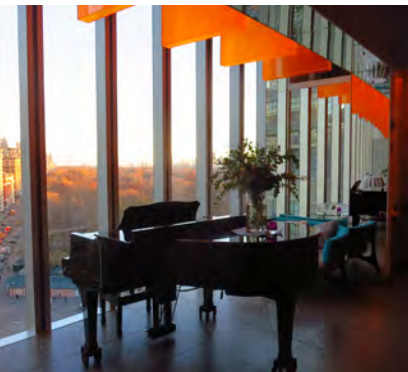



# Floor Plans

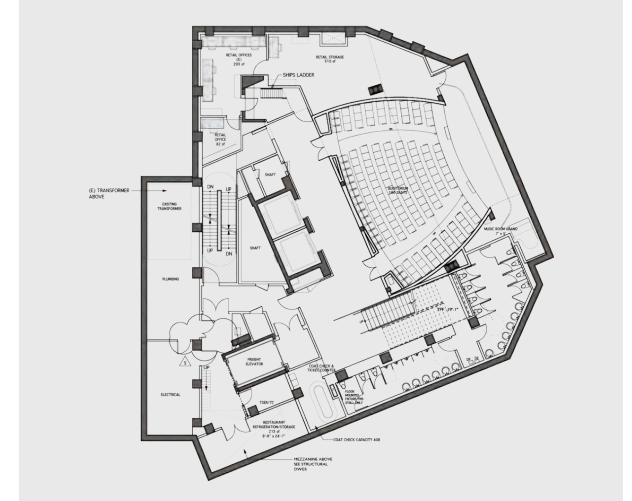
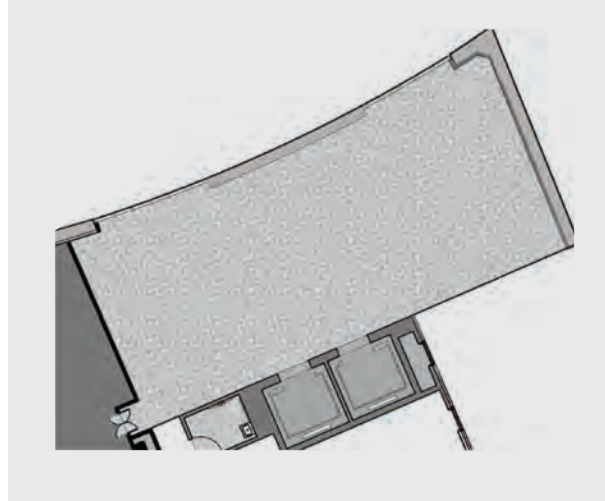
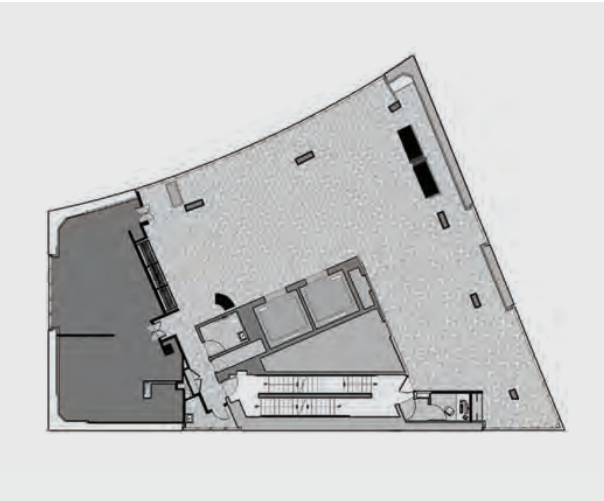

## MAIN DINING ROOM

Cocktail Party: 250  
 Seated Dinner: 160  
 Dinner & Dancing: 120  
 Ceremony & Reception with Dancing: 75

## SEVENTH FLOOR

Cocktail Party: 160  
 Seated Dinner: 100  
 Dinner & Dancing: 70  
 Theater Style: 150

## THEATER LEVEL

Seating: 143



ROBERTNYC.COM

2 COLUMBUS CIRCLE, NEW YORK CITY | 212 206 8815

 @ROBERTRESTAURANT

 ROBERT@MAD